

# GmCLab OPERATOR'S MANUAL

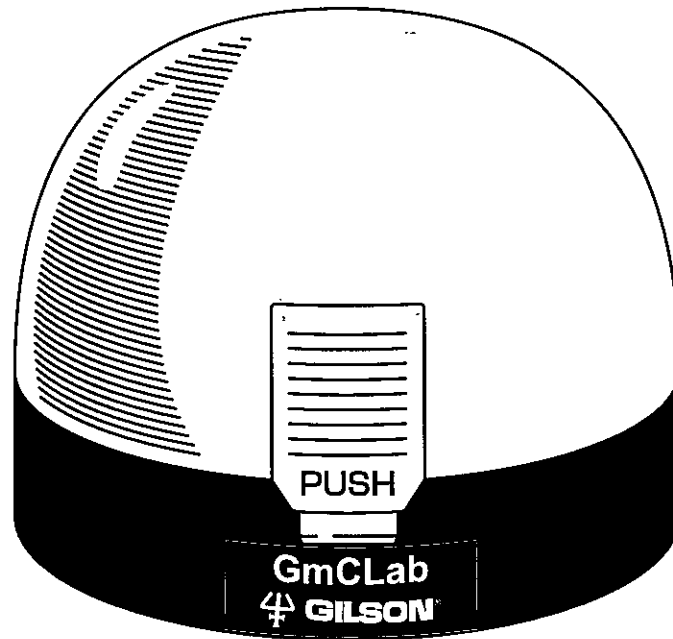

## **Gilson S.A.S.**

19, avenue des Entrepreneurs, BP 145, F-95400 VILLIERS LE BEL France

Tel: (33) 1.34.29.50.00

FAX: (33) 1.34.29.50.90

## **Gilson, Inc. World Headquarters**

3000 Parmenter Street, P.O. Box 620027, Middleton, WI 53562-0027 USA

Phone: 608-836-1551

Fax: 608-831-4451

E-mail: [sales@gilson.com](mailto:sales@gilson.com), [service@gilson.com](mailto:service@gilson.com), [training@gilson.com](mailto:training@gilson.com)

[www.gilson.com](http://www.gilson.com)

# CONTENTS

1. PREFACE.....	1
2. GENERAL PRECAUTIONS.....	2 - 5
3. PARTS IDENTIFICATION.....	6
4. INSTALLATION.....	7 - 8
[1]Moving the Centrifuge.....	7
[2]Installation Site.....	7
[3]Power Outlet.....	8
5. OPERATION.....	9 - 14
[1]To plug the centrifuge.....	9
[2]To turn the power on.....	10
[3]To open the lid.....	10
[4]To mount the rotor.....	10
[5]To load tubes on the rotor.....	11 - 13
[6]To close the lid and start the centrifuge.....	14
[7]To stop the centrifuge.....	14
[8]To turn the power off.....	14
[9]To dismount the rotor.....	14
[10]To unplug the power cord.....	14
6. ROUTINE MAINTENANCE.....	15 - 16
[1]To inspect and clean the rotor.....	16
[2]To inspect the motor shaft boss.....	16
[3]To inspect and clean the chamber.....	16
[4]To inspect the power plug and the outlet.....	16
[5]To inspect the lid and lid lock.....	16
[6]To clean the body.....	16
7. TROUBLESHOOTING.....	17
8. AFTER SERVICE.....	18
9. SPECIFICATIONS.....	19
10. WARRANTY.....	20

# 1. PREFACE

This centrifuge is electrically powered and spins rotors at high speeds. Therefore, certain electrical and mechanical hazards are inherent with its use. Improper installation or misuse will increase your chance of being injured or killed.

This Operator's Manual contains specific instructions pertaining to the proper installation, use and maintenance of the centrifuge. Certain terms and symbols are used throughout this manual to emphasize hazards. We distinguish between the terms and symbols as follows:

## Warning

means that misuse may cause death or serious injury to the operator or persons nearby.

## Caution

means that misuse may cause injury to persons or damage to the centrifuge and surrounding property.

Pay close attention to the information associated with these terms and symbols.

## Warning

Be sure to seat and secure the rotor properly before operation.

Improperly installed rotor may come off the motor shaft and may injure someone.

Do not seat the rotor upside down.

Improperly rotor may come off the motor shaft and may injure someone.

## 2. GENERAL PRECAUTIONS

The followings are general warnings and cautions concerning the use of the centrifuge. Observe these precautions strictly.

### Warning

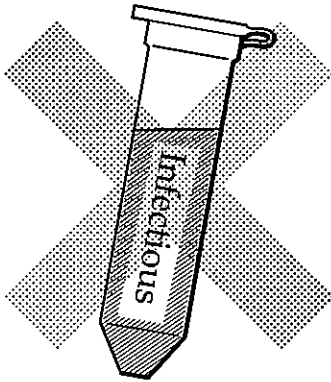

#### **Infectious Sample Aerosols**

This centrifuge is not equipped with a back-up isolation system to contain aerosols in the event a tube leaks or breaks during a run.

If you suspect that exposure to aerosols from samples you are handling could cause permanent or fatal illness, do not put them in this centrifuge.

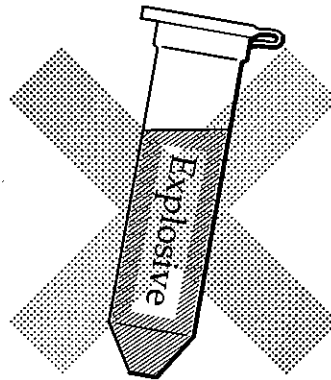

#### **NEVER centrifuge explosive or flammable substances.**

Explosive or flammable items that ignite during a run will cause the centrifuge to explode. This centrifuge does not provide adequate protection from explosions or fires originating in the chamber.

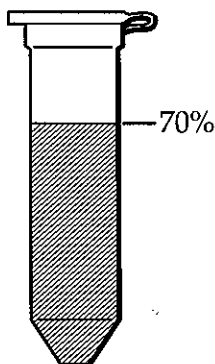

#### **Do not overfill tubes.**

Tubes more than 70 percent full will cause the sample leaking during the run. This will expose you and the centrifuge to sample aerosols that may make you ill or may damage the centrifuge.

# Warning



## Use caps for tubes.

Tubes without caps will cause the sample leaking during the run. This will expose you and the centrifuge to sample aerosols that may make you ill or may damage the centrifuge.

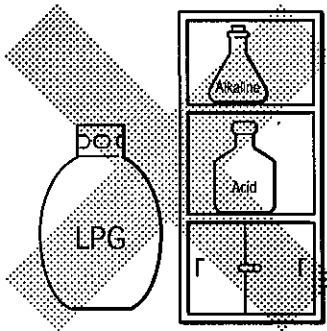

## Do not install the centrifuge near sources of water or gas or near chemical storage areas.

Installation near gas or water generating facing may result in fire, explosion or other damage to the equipment or facility.

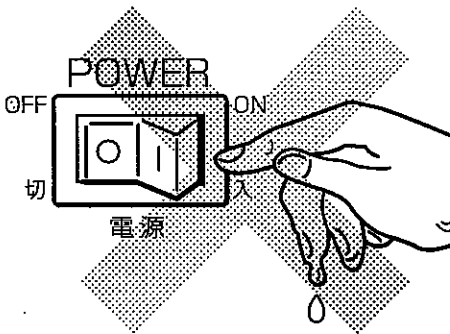

## Do not touch the power switch with wet hands.

You may sustain a serious or deadly electrical shock.

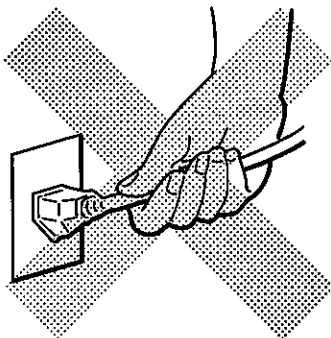

## Do not unplug the centrifuge with pulling the power cord.

Stress to the cord may cause a loose connection in the plug and result in a fire.

# Warning

**Do not touch the power plug with wet hands.**

You may sustain a serious or deadly electrical shock.

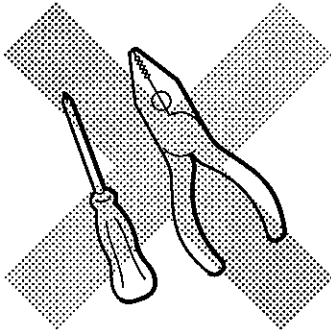
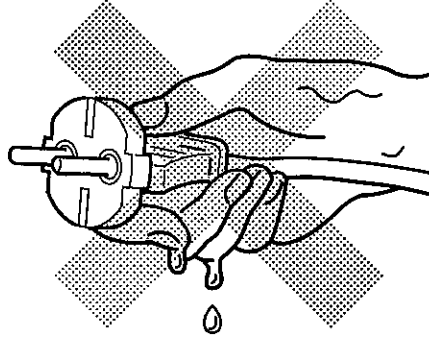
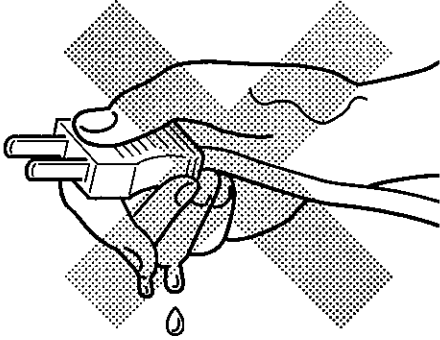

**Do not modify the centrifuge.**

Modification to the centrifuge may cause a serious malfunction, damage the centrifuge or cause injury to someone.

**Unplug the power cord while not using.**

Stress to the cord may cause a loose connection in the plug and result in a fire.

**Do not use accessories or parts other than those specified by the manufacturer.**

Substituted accessories or parts that do not meet the manufacturer's performance specifications may cause serious damage to the centrifuge or injure someone.

# Warning

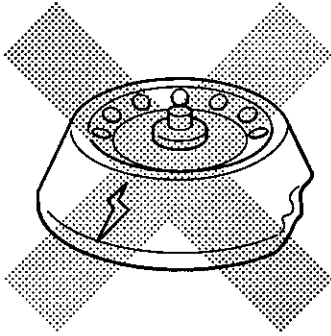

**Do not use damaged or deformed rotors.**

Rotors with compromised structures are subject to sudden and severe imbalances that will damage the centrifuge and may injure someone.

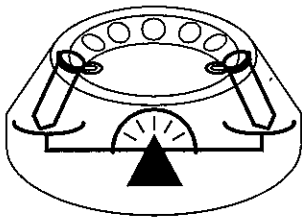

**Be sure to balance the load properly.**

Imbalance loads will significantly reduce the life of the motor and centrifuge. In severe cases, imbalances may damage the centrifuge and injure the operator.

**Do not open the lid until rotor has stopped completely.**

Injury may occur from moving parts.

**Do not replace the fuse other than those specified by the manufacturer.**

That will damage the centrifuge and may injure someone.

### 3. PARTS IDENTIFICATION

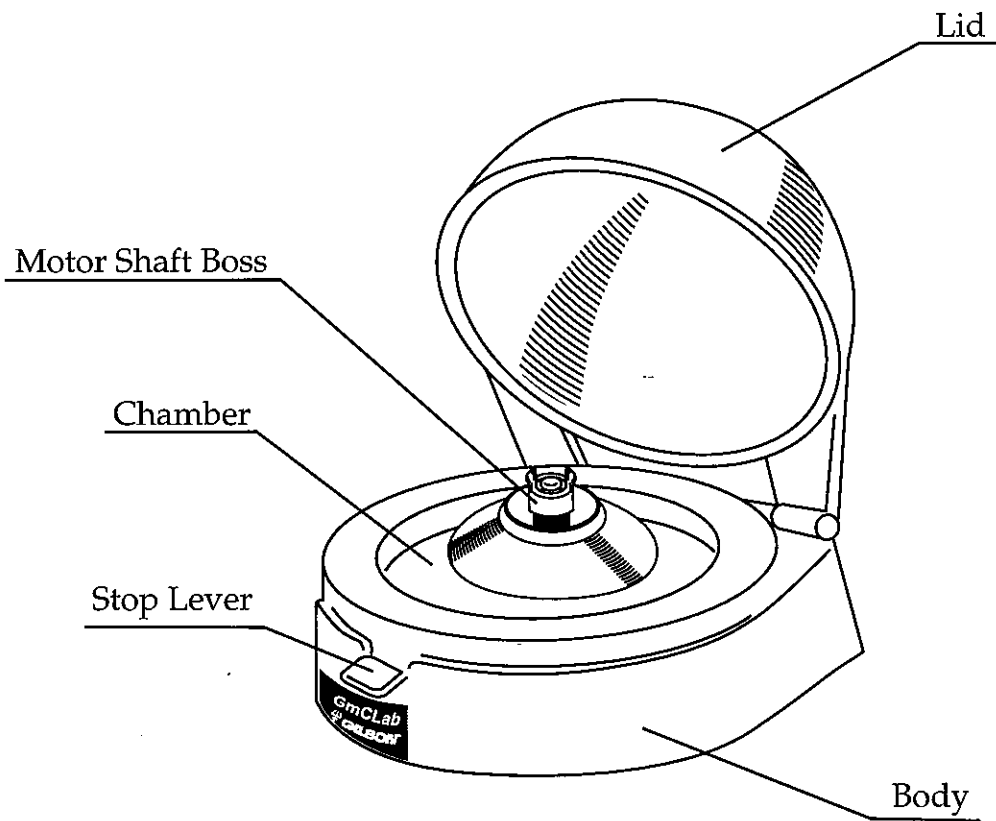

Microtubes Rotor  
MA-1

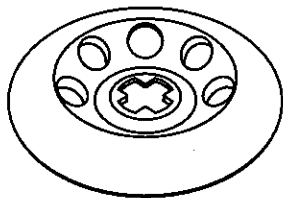

Tube-strips Rotor  
PA-1

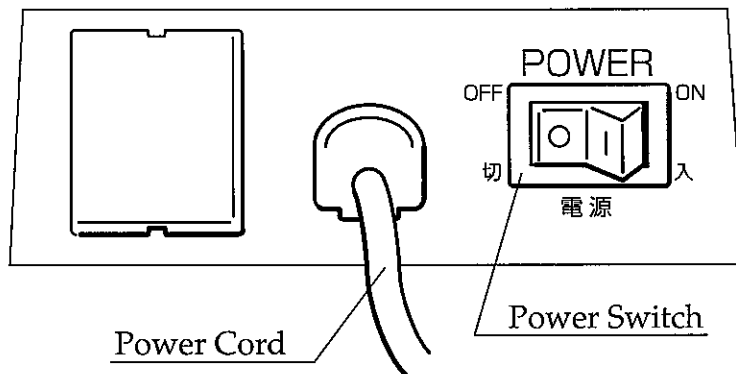
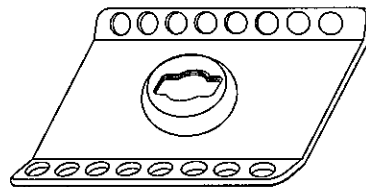



## 4.INSTALLATION

### [1]Moving the Centrifuge

#### Caution

Do not drop the centrifuge or bump into things when moving it.

Do not move the centrifuge with pulling its power cord.

Do not move the centrifuge with pulling its lid.

### [2]Installation Site

#### Warning

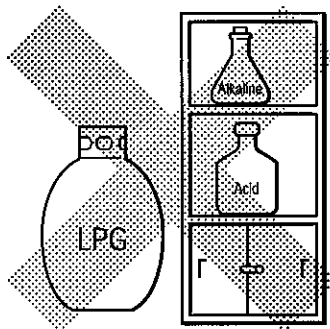

**NEVER install the centrifuge near chemical storage facilities or sites likely to generate flammable gases or fumes.**  
That will damage the centrifuge and may result in a fire.

**Do not leave the centrifuge in a cold room less than 5°C for extended period of time.**  
That will damage the centrifuge and may result in a fire.

#### Caution

Install the centrifuge on a flat and level surface such as a solid surface bench top.

Keep the centrifuge out of direct sunlight, dust and poorly ventilated areas.

- Required Environmental Conditions : Room Temperature : 5 to 35°C  
Atmospheric Pressure : 70 to 106 kPa  
Relative Humidity : 30 to 85 %

[3]Power Outlet

## Caution

Connect the centrifuge to an outlet that is properly rated.

- AC 100V 100mA 50/60Hz
- AC 120V 90mA 50/60Hz
- AC 230V 45mA 50/60Hz

## 5. OPERATION

This section covers the following procedures:

- [1] To plug the centrifuge
- [2] To turn the power on
- [3] To open the lid
- [4] To mount the rotor
- [5] To load tubes on the rotor
- [6] To close the lid and start the centrifuge
- [7] To stop the centrifuge
- [8] To turn the power off
- [9] To dismount the rotor
- [10] To unplug the power cord

[1] To plug the centrifuge

### **Warning**

**Do not touch the power plug with wet hands.**

You may sustain a serious or deadly electrical shock.

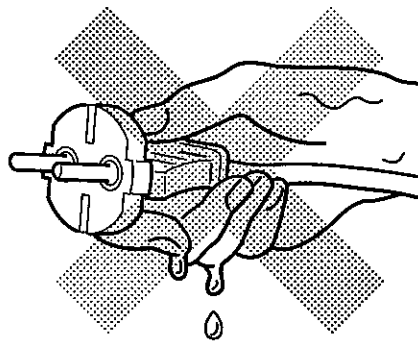
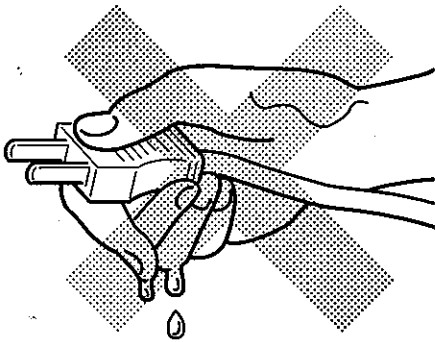

[2]To turn the power on

## Warning

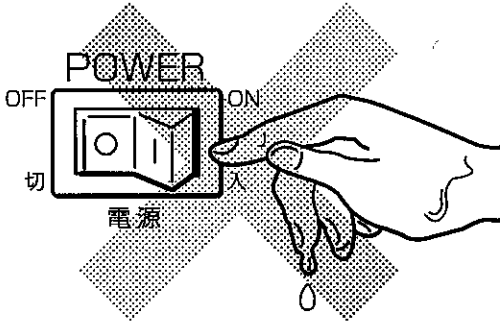

**Do not touch the power switch with wet hands.**

You may sustain a serious or deadly electrical shock.

[3]To open the lid

Press the stop lever down and open the lid.

[4]To mount the rotor

Mount a rotor on the motor shaft observing the shapes of motor shaft boss and the center hole of rotor. Push down the rotor until it clicks.

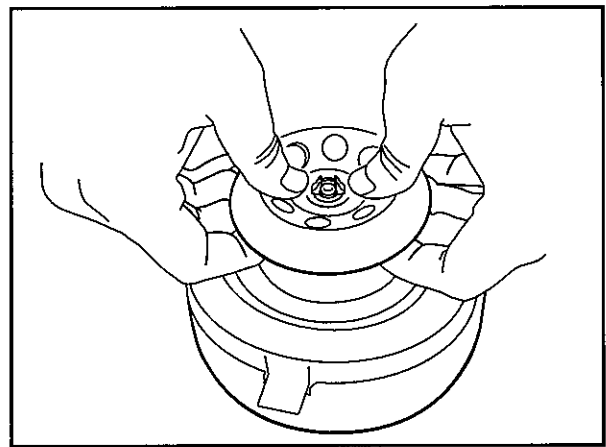
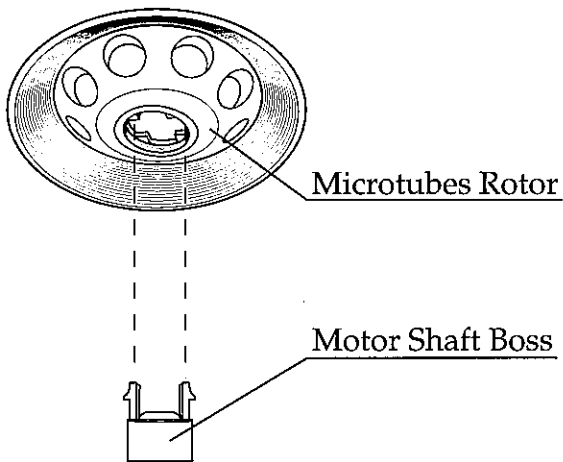

## Warning

Be sure to seat and secure the rotor properly before operation.

Improperly installed rotor may come off the motor shaft and may injure someone.

Do not seat the rotor upside down.

Improperly rotor may come off the motor shaft and may injure someone.

[5]To load tubes on the rotor

## Warning

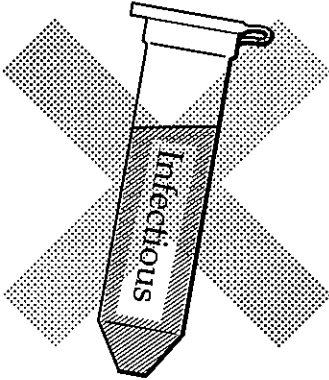

### **Infectious Sample Aerosols**

This centrifuge is not equipped with a back-up isolation system to contain aerosols in the event a tube leaks or breaks during a run.

If you suspect that exposure to aerosols from samples you are handling could cause permanent or fatal illness, do not put them in this centrifuge.

## Warning

**Do not allow water or sample to drop or fall inside the centrifuge.**

This may cause an electrical short or may shock someone.

# Warning

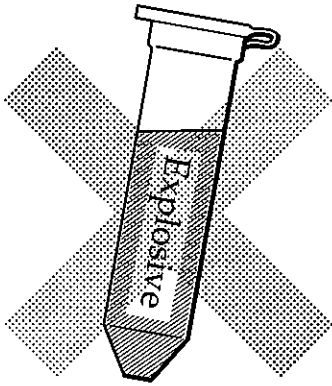

## **NEVER centrifuge explosive or flammable substances.**

Explosive or flammable items that ignite during a run will cause the centrifuge to explode. This centrifuge does not provide adequate protection from explosions or fires originating in the chamber.

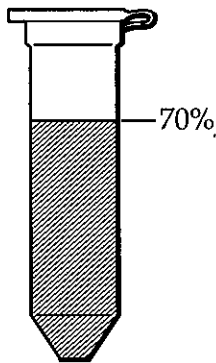

## **Do not overfill tubes.**

Tubes more than 70 percent full will leak during the run. This will expose you and the centrifuge to sample aerosols that may make you ill or may damage the centrifuge.

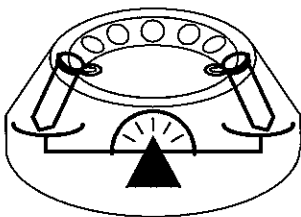

## **Be sure to balance the load properly.**

Imbalance loads will significantly reduce the life of the motor and centrifuge. In severe cases, imbalances may damage the centrifuge and injure the operator.



## **Use caps for tubes.**

Tubes without caps will leak during the run. This will expose you and the centrifuge to sample aerosols that may make you ill or may damage the centrifuge.

Place tubes symmetrically into the rotor.

Imbalance loads will significantly reduce the life of the motor and centrifuge. In severe case, imbalances may damage the centrifuge and injure the operator.

**Microtubes Rotor MA-1**

Place the eight, four or two microtube samples symmetrically into the rotor.

**Correct Tube Placement**

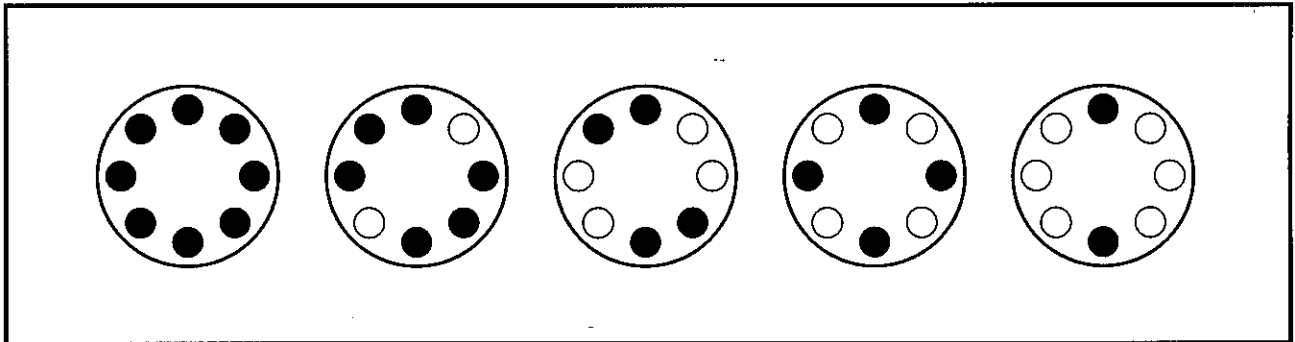

**Tube-strips Rotor PA-1**

Place all two lines tubes into the rotor.

**Correct Tube Placement**

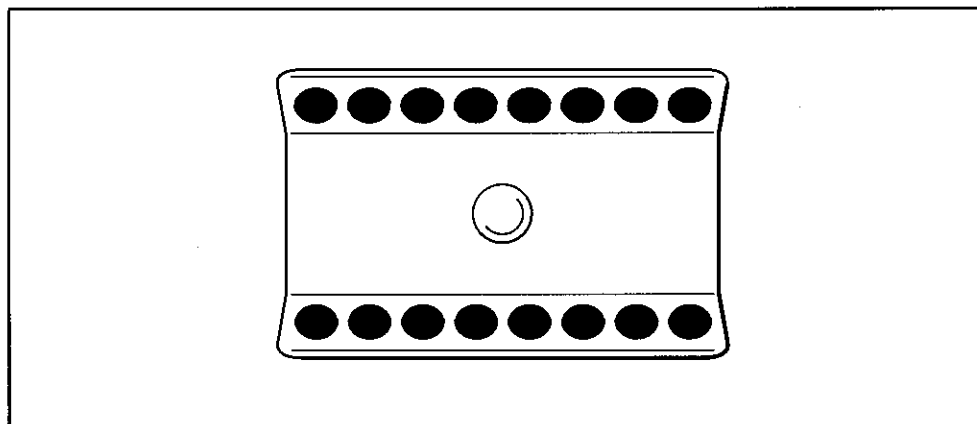

[6]To close the lid and start the centrifuge

Close and firmly press down the lid until the lid locks into position. The rotor will begin spinning when the lid is completely closed.

[7]To stop the centrifuge

Push the stop lever, open the lid and remove the tubes after the rotor has stopped spinning.

[8]To turn the power off

Turn the power switch off.

[9]To dismount the rotor

Pinch the knob of rotor with fingers and pull out the rotor.

[10]To unplug the power cord

Unplug the power cord while not using.

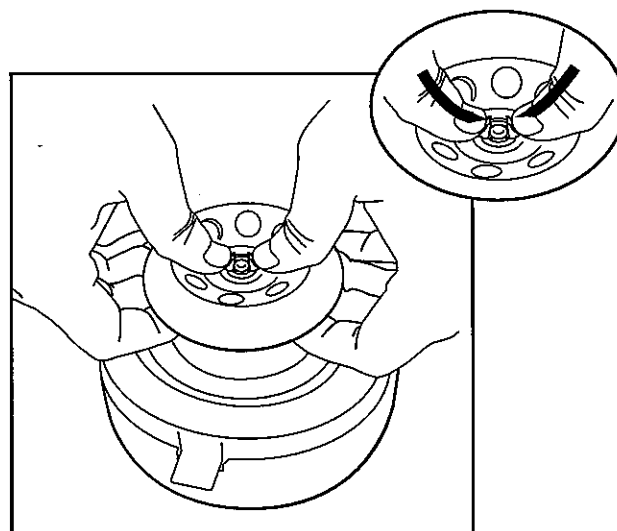

## Warning

**Do not pull out the rotor by force.**

That may bend the motor shaft and damage the motor shaft boss.



## 6. ROUTINE MAINTENANCE



**Never attempt to clean the centrifuge while it is plugged in or when the power is on.**

•If the device or accessories are contaminated by a pathogenic, toxic, or radioactive substance etc., it is the user's responsibility to carry out appropriate decontamination while referring to the "WHO Laboratory Biosafety Manual, 2nd revised edition," etc.

When cleaning and decontamination other than mentioned in this chapter are required, contact our company to check whether or not they are likely to damage the device.

If you are planning to return the device or accessories to our company or are requesting repair, you must contact our company before sending these items to us. In some cases a certificate of implementation of cleaning and decontamination may be required before the items can be sent to us.

Check and clean your centrifuge at regular intervals or immediately after spills occur to prevent premature wear and safety hazards.

# Warning

NEVER attempt to clean the centrifuge while it is plugged in or when the power is on. You may get shocked or you may be injured by moving parts.

[1] To inspect and clean the rotor

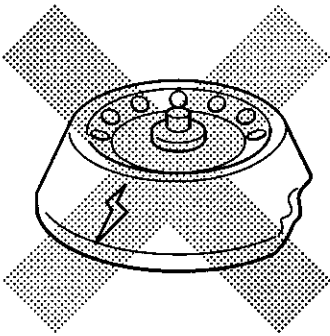

Visually inspect rotor for damage such as dents or chips from being dropped. If the rotor is damaged, do not use the centrifuge and call for service.

Wipe the rotor with a soft cloth moistened with a neutral detergent with extreme care and remove the detergent with a clean damp cloth.

[2] To inspect the motor shaft boss

Visually inspect the rotor for damage or deformation.

Stop the operation and call for service when the rotor is damaged or deformed.

[3] To inspect and clean the chamber

Inspect the chamber for loose debris and excess water and remove as necessary.

Wipe the chamber with a soft cloth moistened with a neutral detergent with extreme care and remove the detergent with a clean damp cloth.

[4] To inspect the power plug and the outlet

Inspect the power plug and outlet for a loose connection and dust.

[5] To inspect the lid and lid lock

Inspect the lid is able to open and close smoothly.

Inspect the lid is locked when pressing down.

[6] To clean the body

Wipe the body with a soft cloth moistened with a neutral detergent with extreme care and remove the detergent with a clean damp cloth.

## 7. TROUBLESHOOTING

Use the following troubleshooting procedures to resolve problems with the centrifuge. If the centrifuge still does not run properly, please contact your local dealer.

NOTE : Clean and decontaminate your centrifuge before you ship it back for service or before you allow a service technician to repair it.

Symptom	Probable Cause	Solution
The centrifuge won't run.	The power cord is unplugged.	Plug the power cord in.
	The fuse is blown.	Call for service.
	Motor carbon brushes lost conductivity because of a long term inventory.	Turn the rotor five or six times gently by hand.
	Foreign articles wind around the rotor shaft.	Remove the foreign articles after unplugging the centrifuge.
	The motor is near the end of its expected life.	Call for service.
Abnormal noise	Imbalanced loads	Balance the load properly.
The centrifuge vibrates abnormally.	Foreign articles is sticking on the rotor or chamber.	Remove the foreign articles after unplugging the centrifuge.
	Defective motor	Call for service.
The rotor won't be installed properly.	The rotor is seated upside down.	Seat the rotor properly.
	Damaged or deformed rotor or motor shaft boss.	Call for service.

## 8. AFTER SERVICE

To replace the motor

The centrifuge uses carbon brushes in the motor. It is necessary to replace the whole motor when carbon brushes are worn. Call for service. Please note that the motor is out of the warranty.

The expected life for motor is several years with normal use or several months when the centrifuge is used very often.

For Assistance or Service Contact :

For assistance or service, please contact your local dealer.

## 9. SPECIFICATIONS

Model	GmCLab	
Rotor	Microtubes Rotor MA-1	Tube-strips Rotor PA-1
Speed	6,000rpm( $\pm 20\%$ )	6,200rpm( $\pm 20\%$ )
Force	1,290~2,910 G	Max. 1,200~2,690 G Min. 810~1,820 G
Maximum Volume	1.5(2.2)ml x 8 tubes	0.2 ml x 8 tubes connected x 2 lines
Power Required	AC100V,1A,50/60Hz AC120V,1A,50/60Hz AC230V,1A,50/60Hz(☐)	
Fuse	250V 0.5A	
Dimensions	155W x 175D x 125H mm	
Material	Lid	PC(UL 94V-0)
	Body	ABS(UL 94V-0)
	Actuator	ABS(UL 94V-0)
	Rubber	NBR
	Rotor	ABS(UL 94V-0)
Speed Control	Automatic / Constant Speed	
Drive System	Direct Drive / Vibration Insulated	
Brake	Dynamic Braking	
Acceleration Time	Within 5 seconds up to 90% of rated speed	
Deceleration Time	Within 15 seconds (Lid Close) Within 3 seconds (Lid Open)	

## 10. WARRANTY

You have purchased a Gilson laboratory personal centrifuge which meets the highest engineering and quality standards.

In accordance with Gilson warranty conditions, the warranty period is 12 months.



## Waste Electrical and Electronic Equipment (WEEE) Statement

The European Union enacted Directive 2002/96/EC of the European Parliament and of the Council of 27 January 2003 on Waste Electrical and Electronic Equipment (WEEE). The text of the EU directive can be found at: [http://europa.eu.int/comm/environment/waste/weee\\_index.htm](http://europa.eu.int/comm/environment/waste/weee_index.htm).

Gilson, Inc. and Gilson SAS will apply Annex IV labeling (shown below)-including the heavy underscore that indicates the instrument was manufactured after 13 August 2005-to all instruments.

### Unit End-of-Life



When a unit reaches the end of its useful life, refer to [www.gilson.com](http://www.gilson.com) for directions and information on the end-of-life policy. This is in accordance with the European Union Directive 2002/96/EC on Waste Electrical and Electronic Equipment (WEEE).

Gilson, Inc. World Headquarters  
3000 Parmenter Street · P.O. Box 620027 · Middleton, WI 53562 USA  
Phone: 608-836-1551 · Fax: 608-831-4451 · E-mail: [sales@gilson.com](mailto:sales@gilson.com), [service@gilson.com](mailto:service@gilson.com), [training@gilson.com](mailto:training@gilson.com) ·  
[www.gilson.com](http://www.gilson.com)

Gilson S.A.S. · 19, avenue des Entrepreneurs, F-95400 VILLIERS LE BEL France

